











**ABD Addition 8162019**

Item	Qty.	Product	Price	
			Unit	Extended
1	4	<b>TYRQ36</b> Slim Profile Utility Light, 36" w	\$109.35	\$437.40
			0	Standard
			0	Light Only
			A	Canada/USA
			~Foundat	Foundation Colors
			52	Ebony (Satin)
2	2	<b>DP150</b> Pencil Drawer	\$19.92	\$39.84
			E	Black
3	1	<b>RVUSM243048541</b> Ext. Corner Desk w/Met. Full & 1/2 Gables, 24" dAx30" dBx48" wAx54" wB, L WS, L Gbl ADDITIONAL Special Features To have a Bow top on the 54" side of the desk. This is an add on to the same project as CR 130904	\$790.42	\$790.42
			~A	Foundation Laminate
			2D	Choice Maple
			6	Straight Trim
			4D	Choice Maple
			~Found	Foundation (for gables & grommets)
			E	Ebony (Satin)
4	1	<b>RVUSM242448842</b> Ext. Corner Desk w/Met. Full & 1/2 Gables, 24" dAx24" dBx48" wAx84" wB, R WS, R Gbl	\$768.64	\$768.64
			~A	Foundation Laminate
			2D	Choice Maple
			6	Straight Trim
			4D	Choice Maple
			~Found	Foundation (for gables & grommets)
			E	Ebony (Satin)
5	3	<b>KCC813</b> Three-Way Connector, 81" h	\$44.55	\$133.65
			~Foundat	Foundation Colors
			E	Ebony (Satin)

Item	Qty.	Product	Price	
			Unit	Extended
6	1	<b>KCCN8190</b> Two-Way Connector 90 Degree, 81"h	\$64.26	\$64.26
			~Foundat E	Foundation Colors Ebony (Satin) Wide Gasket
7	5	<b>KCW81</b> Panel Wall Adapter, 81"h	\$35.10	\$175.50
			~Foundat E	Foundation Colors Ebony (Satin)
8	9	<b>KEGW3041524</b> Symmetric Architectural Glazed Element, Louvered, 15"h x 24"w	\$67.50	\$607.50
			~Foundat E	Foundation Colors Ebony (Satin)
9	3	<b>KEGW3041536</b> Symmetric Architectural Glazed Element, Louvered, 15"h x 36"w	\$89.64	\$268.92
			~Foundat E	Foundation Colors Ebony (Satin)
10	6	<b>KEGW3041542</b> Symmetric Architectural Glazed Element, Louvered, 15"h x 42"w	\$102.06	\$612.36
			~Foundat E	Foundation Colors Ebony (Satin)
11	15	<b>KEGW3041548</b> Symmetric Architectural Glazed Element, Louvered, 15"h x 48"w	\$109.35	\$1,640.25
			~Foundat E	Foundation Colors Ebony (Satin)

**ABD Addition 8162019**



Item	Qty.	Product	Price	
			Unit	Extended
1	4	<b>TYRQ36</b> Slim Profile Utility Light, 36" w	\$109.35	\$437.40
			0	Standard
			0	Light Only
			A	Canada/USA
			~Foundat	Foundation Colors
			52	Ebony (Satin)
2	2	<b>DP150</b> Pencil Drawer	\$19.92	\$39.84
			E	Black
3	1	<b>RVUSM243048541</b> Ext. Corner Desk w/Met. Full&1/2 Gables, 24"dAx30"dBx48"wAx54"wB, L WS, L Gbl ADDITIONAL Special Features To have a Bow top on the 54" side of the desk. This is an add on to the same project as CR 130904	\$790.42	\$790.42
			~A	Foundation Laminate
			2D	Choice Maple
			6	Straight Trim
			4D	Choice Maple
			~Found	Foundation (for gables & grommets)
			E	Ebony (Satin)
4	1	<b>RVUSM242448842</b> Ext. Corner Desk w/Met. Full&1/2 Gables, 24"dAx24"dBx48"wAx84"wB, R WS, R Gbl	\$768.64	\$768.64
			~A	Foundation Laminate
			2D	Choice Maple
			6	Straight Trim
			4D	Choice Maple
			~Found	Foundation (for gables & grommets)
			E	Ebony (Satin)
5	3	<b>KCC813</b> Three-Way Connector, 81"h	\$44.55	\$133.65
			~Foundat	Foundation Colors
			E	Ebony (Satin)

Item	Qty.	Product	Price	
			Unit	Extended
6	1	<b>KCCN8190</b> Two-Way Connector 90 Degree, 81"h	\$64.26	\$64.26
			~Foundat E	Foundation Colors Ebony (Satin) Wide Gasket
7	5	<b>KCW81</b> Panel Wall Adapter, 81"h	\$35.10	\$175.50
			~Foundat E	Foundation Colors Ebony (Satin)
8	9	<b>KEGW3041524</b> Symmetric Architectural Glazed Element, Louvered, 15"h x 24"w	\$67.50	\$607.50
			~Foundat E	Foundation Colors Ebony (Satin)
9	3	<b>KEGW3041536</b> Symmetric Architectural Glazed Element, Louvered, 15"h x 36"w	\$89.64	\$268.92
			~Foundat E	Foundation Colors Ebony (Satin)
10	6	<b>KEGW3041542</b> Symmetric Architectural Glazed Element, Louvered, 15"h x 42"w	\$102.06	\$612.36
			~Foundat E	Foundation Colors Ebony (Satin)
11	15	<b>KEGW3041548</b> Symmetric Architectural Glazed Element, Louvered, 15"h x 48"w	\$109.35	\$1,640.25
			~Foundat E	Foundation Colors Ebony (Satin)



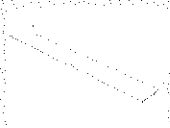

Item	Qty.	Product	Price	
			Unit	Extended
12	6	<b>KESS3024</b> Acoustic Element, Standard Width, 30"h x 24"w	\$18.90	\$113.40
			~1 ~10 P409	Teknion Fabric Gr.1 Peru Callao
13	12	<b>KESS3036</b> Acoustic Element, Standard Width, 30"h x 36"w	\$27.00	\$324.00
			~1 ~10 P409	Teknion Fabric Gr.1 Peru Callao
14	4	<b>KESS3042</b> Acoustic Element, Standard Width, 30"h x 42"w	\$31.86	\$127.44
			~1 ~10 P409	Teknion Fabric Gr.1 Peru Callao
15	30	<b>KESS3048</b> Acoustic Element, Standard Width, 30"h x 48"w	\$35.91	\$1,077.30
			~1 ~10 P409	Teknion Fabric Gr.1 Peru Callao
16	1	<b>KPF8142L</b> Privacy Screen - Flat, 81"h x 42"w	\$400.68	\$400.68
			~Foundat E	Foundation Colors Ebony (Satin)
17	4	<b>KPF8142R</b> Privacy Screen - Flat, 81"h x 42"w	\$400.68	\$1,602.72
			~Foundat E	Foundation Colors Ebony (Satin)

Item	Qty.	Product	Price	
			Unit	Extended
18	6	<b>KPOW1524</b> Symmetric Panel Add-On, 15"h x 24"w	\$52.11	\$312.66
			~Foundat E ~ ~	Foundation Colors Ebony (Satin) Wide Gasket Bare Frame
19	3	<b>KPOW1536</b> Symmetric Panel Add-On, 15"h x 36"w	\$55.89	\$167.67
			~Foundat E ~ ~	Foundation Colors Ebony (Satin) Wide Gasket Bare Frame
20	4	<b>KPOW1542</b> Symmetric Panel Add-On, 15"h x 42"w	\$56.43	\$225.72
			~Foundat E ~ ~	Foundation Colors Ebony (Satin) Wide Gasket Bare Frame
21	12	<b>KPOW1548</b> Symmetric Panel Add-On, 15"h x 48"w	\$60.21	\$722.52
			~Foundat E ~ ~	Foundation Colors Ebony (Satin) Wide Gasket Bare Frame
22	3	<b>KPWT5124</b> Conventional Panel - Standard, 51"h x 24"w	\$83.43	\$250.29
			~Foundat E ~ ~	Foundation Colors Ebony (Satin) Wide Gasket Bare Frame
23	2	<b>KPWT5142</b> Conventional Panel - Standard, 51"h x 42"w	\$98.28	\$196.56
			~Foundat E ~ ~	Foundation Colors Ebony (Satin) Wide Gasket Bare Frame

Item	Qty.	Product	Price	
			Unit	Extended
24	3	KPWT5148 Conventional Panel - Standard, 51"h x 48"w	\$102.33	\$306.99
			~Foundat E ~ ~	Foundation Colors Ebony (Satin) Wide Gasket Bare Frame
25	14	RPSC37 Structural Column, 37"h	\$48.31	\$676.34
			~Found E	Foundation Colors Ebony (Satin)
26	3	RPSC13 Structural Column, 13"h	\$24.95	\$74.85
			~Found E	Foundation Colors Ebony (Satin)
27	11	KTE81 Panel End Trim, 81"h	\$16.74	\$184.14
			~Foundat E ~	Foundation Colors Ebony (Satin) Wide Gasket
28	3	KTR24 Top Trim, 24"w	\$8.37	\$25.11
			~Foundat E	Foundation Colors Ebony (Satin)
29	3	KTR36 Top Trim, 36"w	\$9.72	\$29.16
			~Foundat E	Foundation Colors Ebony (Satin)

Item	Qty.	Product	Price	
			Unit	Extended
30	2	<b>KTR42</b> Top Trim, 42"w	\$10.53	\$21.06
			~Foundat E	Foundation Colors Ebony (Satin)
31	9	<b>KTR48</b> Top Trim, 48"w	\$11.61	\$104.49
			~Foundat E	Foundation Colors Ebony (Satin)
32	3	<b>RBSPM22286612</b> Pedestal, Mobile, 22"d x 28"h, Box, Box, File	\$303.73	\$911.19
			~S LE BL LE 9 ~Found E K	Source Laminate Ebony Black Ebony Rectilinear Foundation Colors Ebony (Satin) Key Alike
33	2	<b>RDMOF54N</b> Flush-Mounted Mod. Panel, Full-Height, 54"w, Solid	\$96.62	\$193.24
			~Found E ~	Foundation Colors Ebony (Satin) Without Grommet
34	3	<b>RDRSM2436R</b> Rectangular Desk w/ Metal Full and Half Gables, 24"d x 36"w	\$432.04	\$1,296.12
			~A 2D 6 SB ~Found E	Foundation Laminate Choice Maple Straight Trim *D* Maple Print Foundation (for gables & grommets) Ebony (Satin)
35	5	<b>RLDCC3P144</b> Worksurface Power And Communication Center, 3-Wire (Plug-In), 144" long	\$93.46	\$467.30
			A	Canada/ U.S.A.

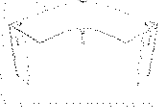

Item	Qty.	Product	Price	
			Unit	Extended
36	1	<b>RVUSM243048542</b> Ext. Corner Desk w/Met. Full & 1/2 Gables, 24"d x 30"d x 48"w x 54"w B, R WS, R Gbl ADDITIONAL Special Features To have a Bow top on the 54" side of the desk. This is an add on to the same project as CR 130904	\$790.42	\$790.42
			~A Foundation Laminate 2D Choice Maple 6 Straight Trim 4D Choice Maple ~Found Foundation (for gables & grommets) E Ebony (Satin)	
37	1	<b>RVUSM242448841</b> Ext. Corner Desk w/Met. Full & 1/2 Gables, 24"d x 24"d x 48"w x 84"w B, L WS, L Gbl	\$768.64	\$768.64
			~A Foundation Laminate 2D Choice Maple 6 Straight Trim 4D Choice Maple ~Found Foundation (for gables & grommets) E Ebony (Satin)	
38	3	<b>RVRDM2448</b> Radius Corner Desk w/ Metal Half Gables, 24"d x 48"w ADDITIONAL Special Features Complete with Full Gable on Left Side	\$642.71	\$1,928.13
			~A Foundation Laminate 2D Choice Maple 6 Straight Trim 4D Choice Maple ~Found Foundation (for gables & grommets) E Ebony (Satin)	
<b>Sub-total</b>				<b>\$18,836.88</b>

**REUSE X1**

39	5	<b>KPWT6648</b> Conventional Panel - Standard, 66"h x 48"w	\$111.78	\$558.90
			~Foundat Foundation Colors E Ebony (Satin) ~ Wide Gasket ~ Bare Frame	
<b>Sub-total REUSE X1</b>				<b>\$558.90</b>

**REUSE X2**

40	1	<b>KPWT6636</b> Conventional Panel - Standard, 66"h x 36"w	\$97.74	\$97.74
			~Foundat Foundation Colors E Ebony (Satin) ~ Wide Gasket ~ Bare Frame	

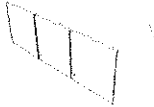
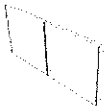
Item	Qty.	Product	Price	
			Unit	Extended
41	2	<b>ROCCC1648</b> Overhead Cabinet - Solid Hinged Doors, Column Mounted, 16"d x 48"w	\$306.90	\$613.80
				
			~S Source Laminate	
			3D Choice Maple	
			4D Choice Maple	
			~Found Foundation Colors	
			E Ebony (Satin)	
			K Key Alike	
42	1	<b>ROCCC1636</b> Overhead Cabinet - Solid Hinged Doors, Column Mounted, 16"d x 36"w	\$245.52	\$245.52
				
			~S Source Laminate	
			3D Choice Maple	
			4D Choice Maple	
			~Found Foundation Colors	
			E Ebony (Satin)	
			K Key Alike	
			<b>Sub-total REUSE X2</b>	<b>\$957.06</b>
<b>X</b>				
43	1	<b>INSTALL</b> Wall Start Build Outs	\$200.00	\$200.00
44	1	<b>INSTALL</b> Installation Cost of Purchased Parts	\$1,533.33	\$1,533.33
45	6	<b>DESIGN</b> Billable Hours	\$65.00	\$390.00
			<b>Sub-total X</b>	<b>\$2,123.33</b>

**Total: \$22,476.17**

Please add Iowa Sales Tax to all orders



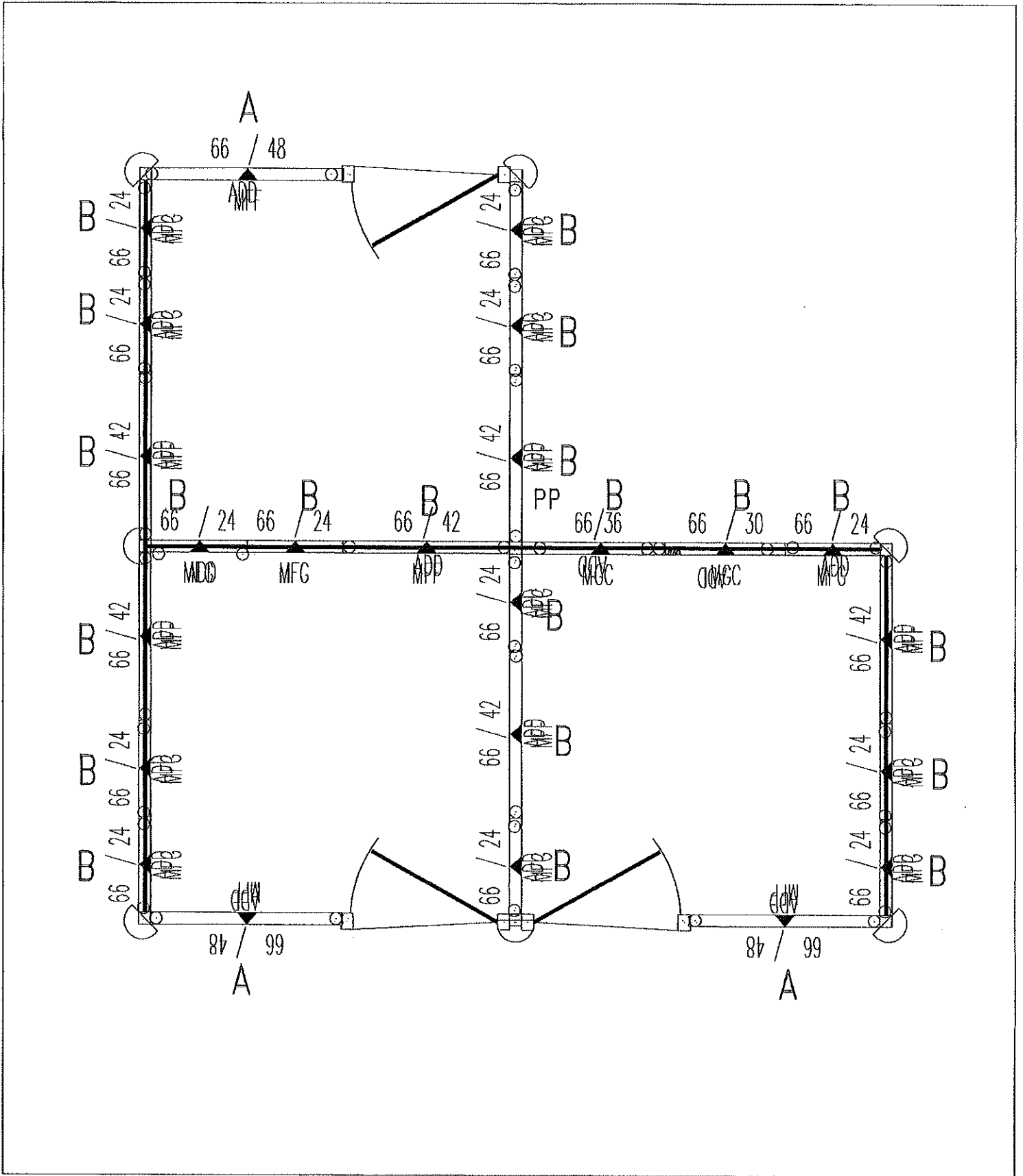

ALCOHOL & BEVERAGE BUILDING: 1ST FLOOR AREA 1 – 83H PANELS

1918 SE HULSIZER DRIVE, ANKENY  
 SCALE: 3/16" = 1'-0"  
 07.15.2019

PROPOSED PANEL PLAN



65H FRAME W/  
18H STACK

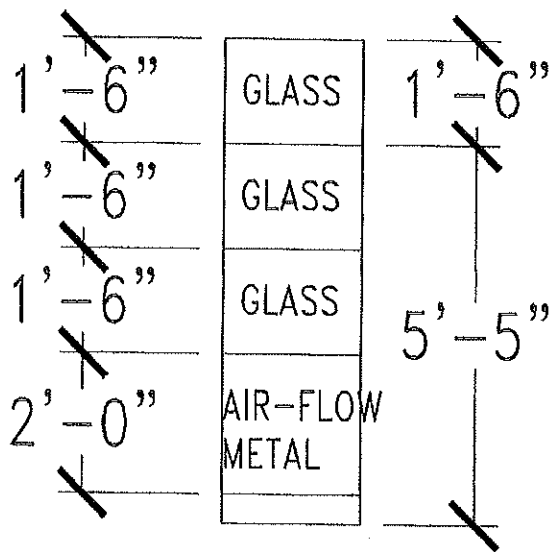

PANEL A

65H FRAME W/  
18H STACK

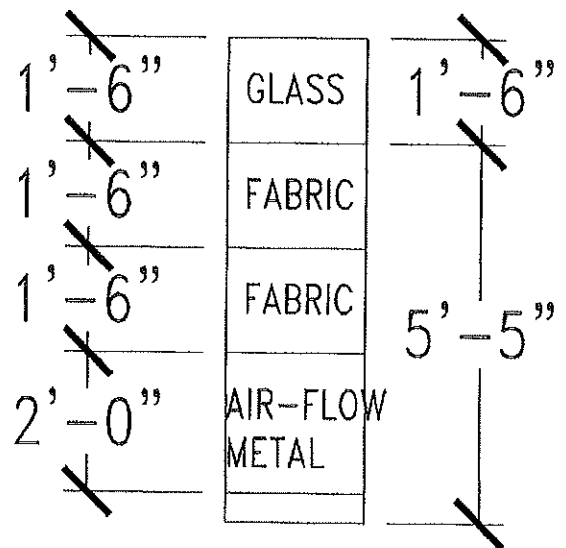

PANEL B









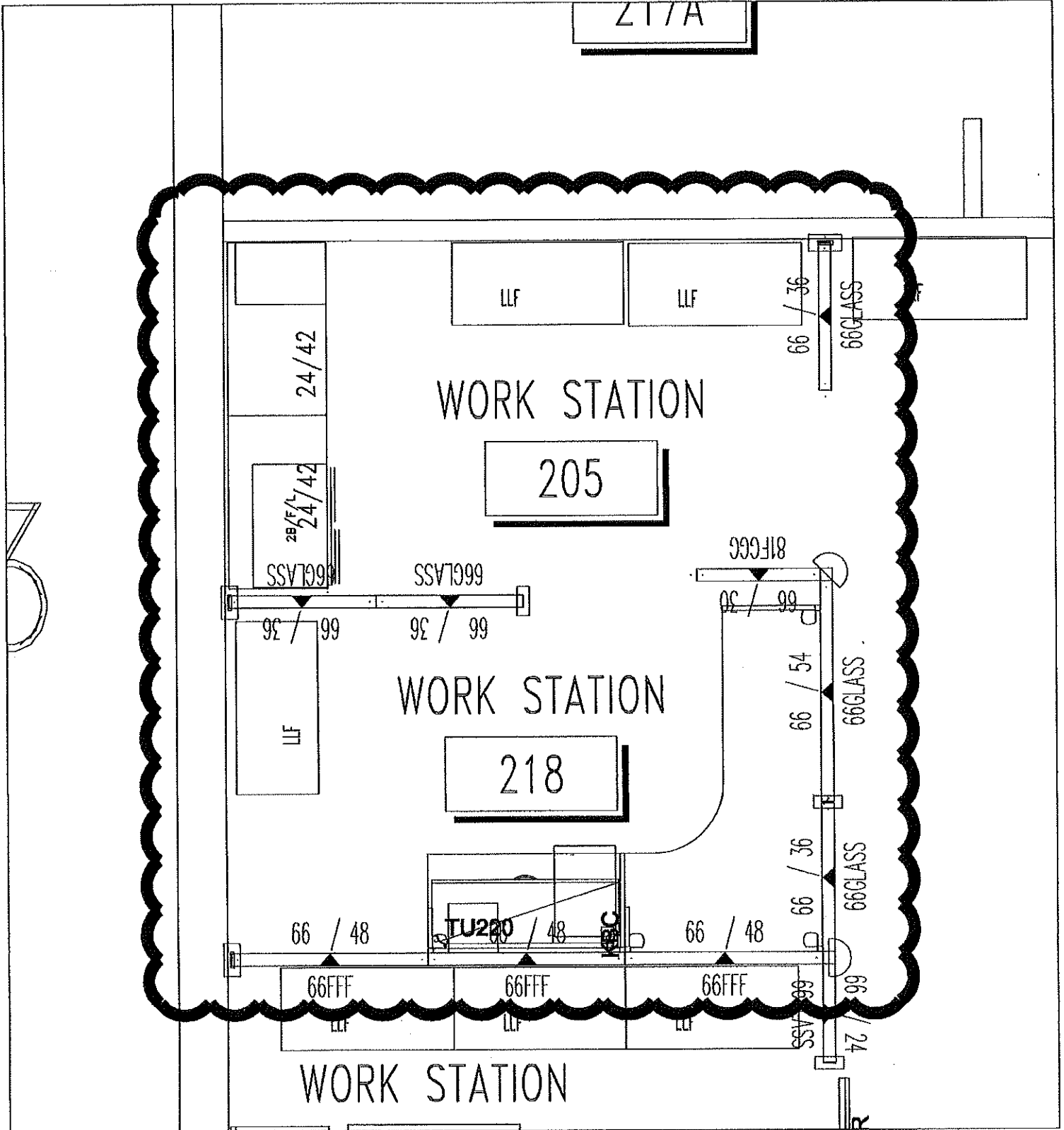

ALCOHOL & BEVERAGE BUILDING: 2ND FLOOR-AREA 3

1918 SE HULSIZER DRIVE, ANKENY  
 SCALE: 3/8" = 1'-0"  
 04.15.2019

EXISTING PLAN



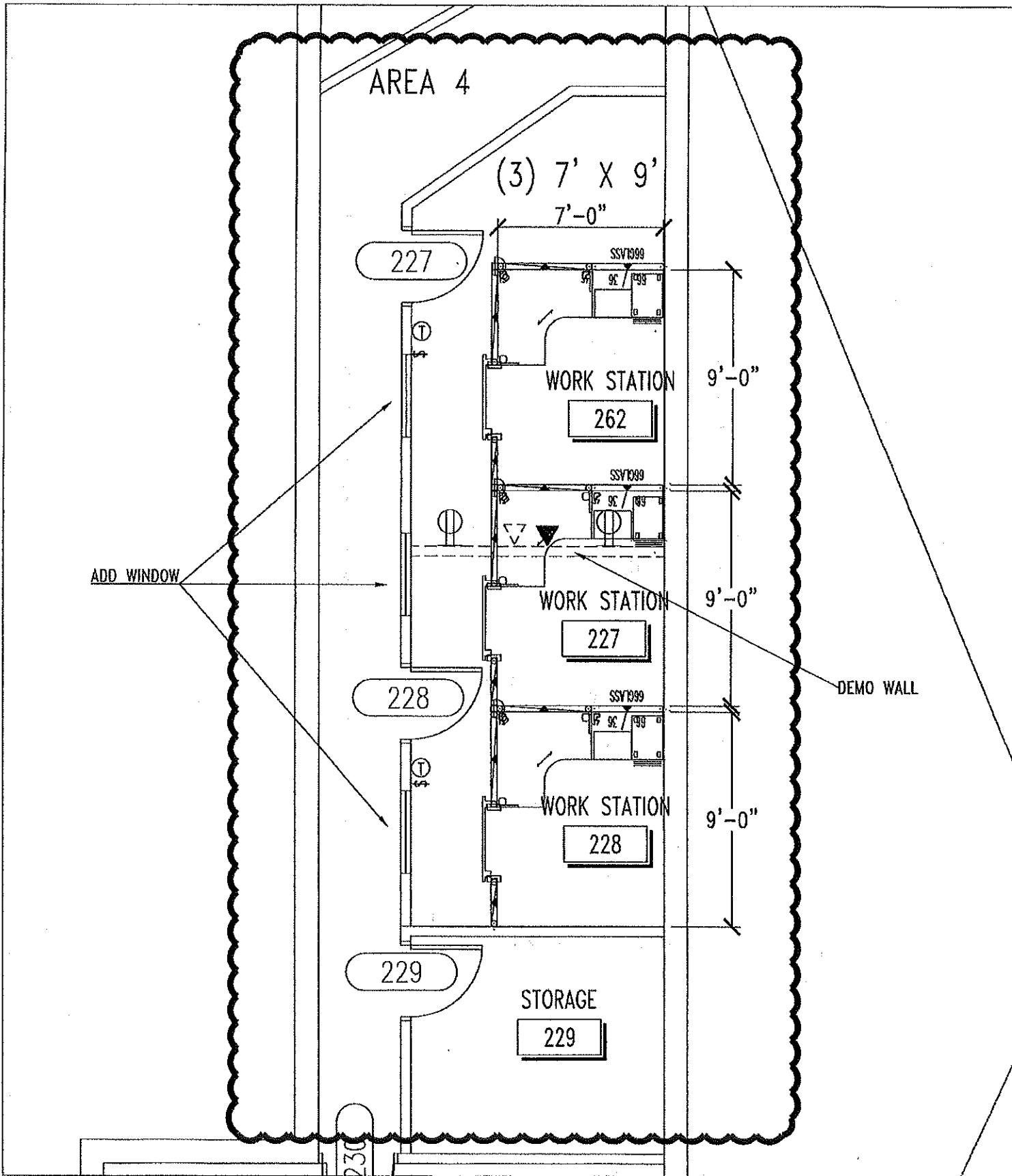

ALCOHOL & BEVERAGE BUILDING: 2ND FLOOR-AREA 4

1918 SE HULSIZER DRIVE, ANKENY  
 SCALE: 3/16" = 1'-0"  
 05.10.2019

PROPOSED PLAN



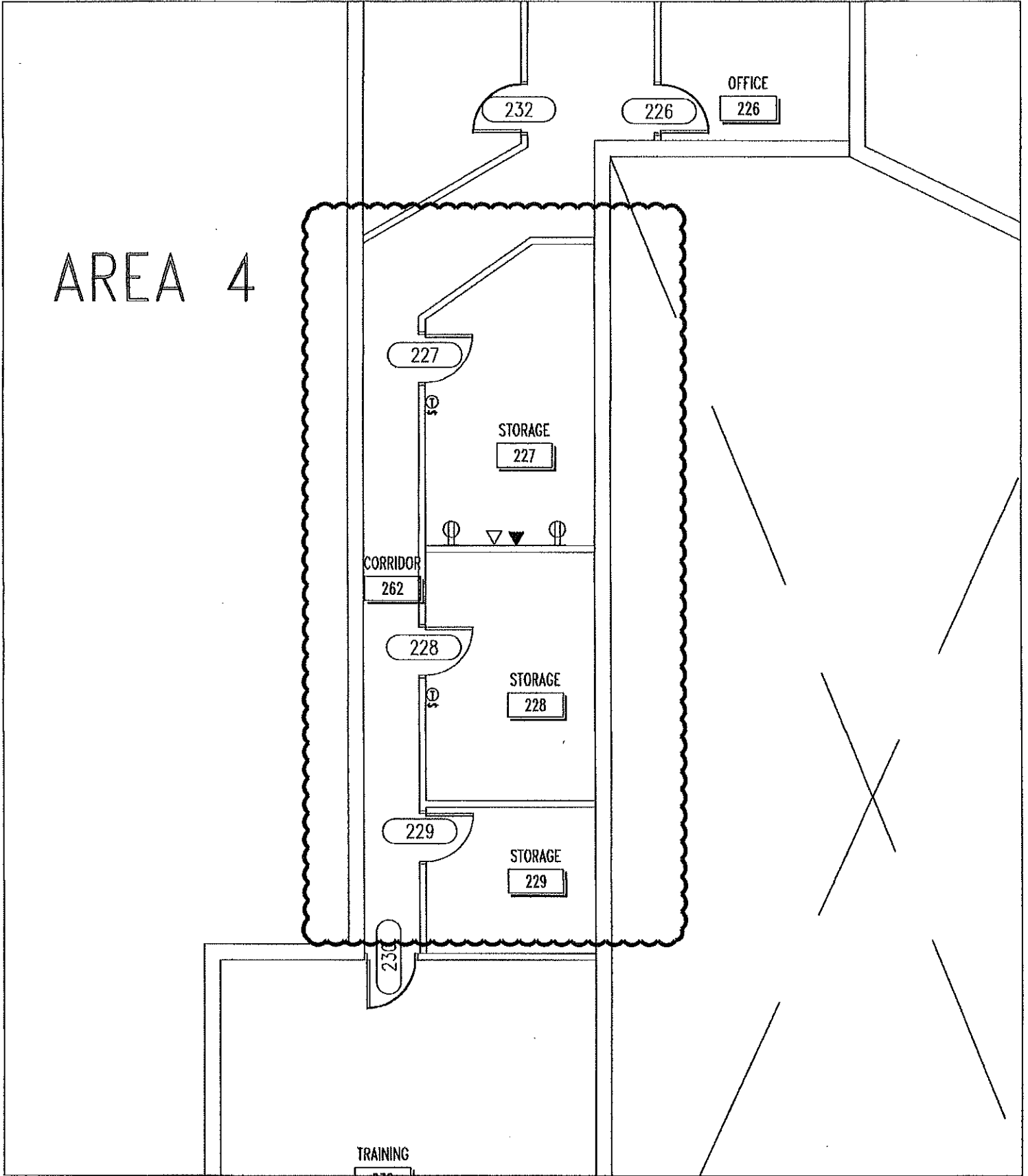

ALCOHOL & BEVERAGE BUILDING: 2ND FLOOR—AREA 4

1918 SE HULSIZER DRIVE, ANKENY  
 SCALE: 1/8" = 1'-0"  
 04.15.2019

EXISTING PLAN

